

# Example

170 x 95 x 72

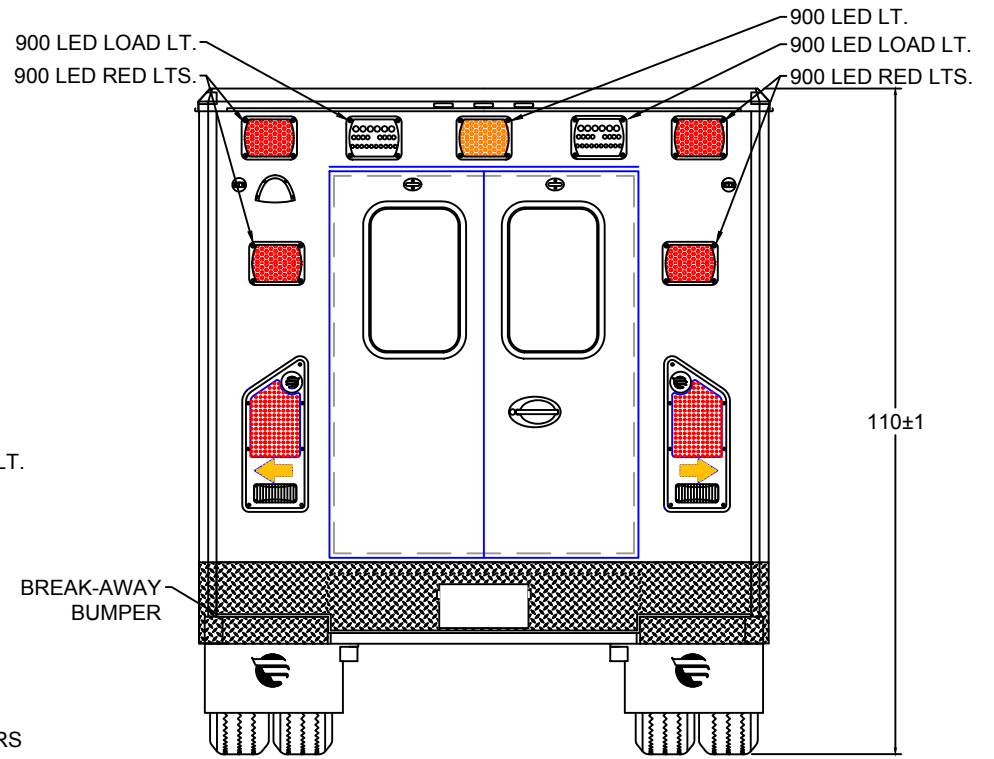
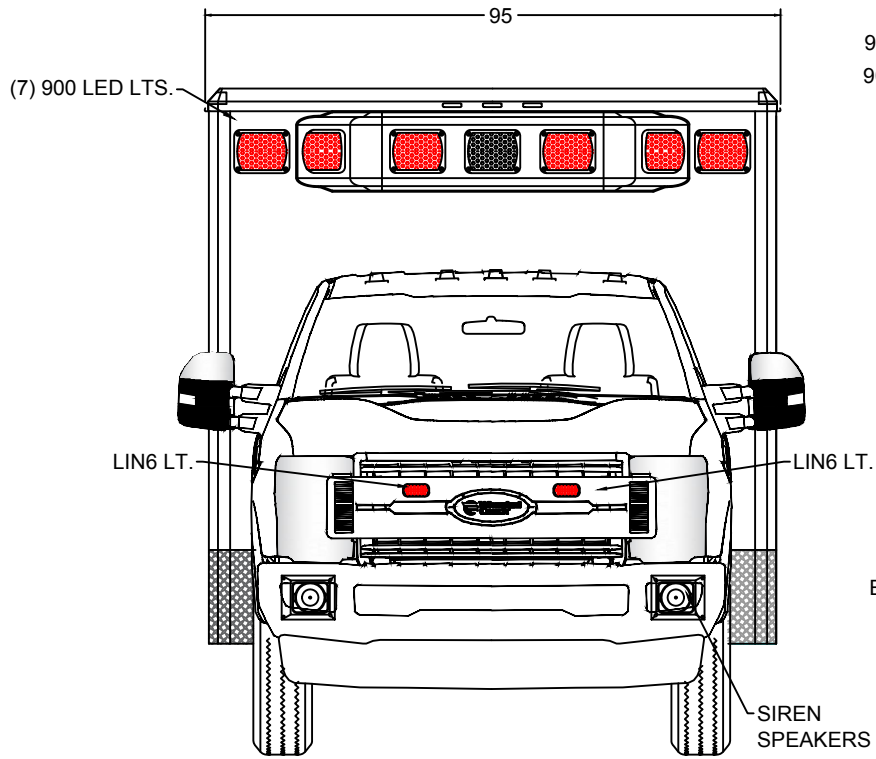

EXTERIOR COMPARTMENT DIMENSIONS IN INCHES												TYPE 1 FORD 2020 FRONT / REAR EXTERIOR VIEWS
INTERIOR DIMENSIONS				PASS THRU		INTERIOR DIMENSIONS				JAMB OPENING		
COMPT.	HEIGHT	WIDTH	DEPTH	HEIGHT	WIDTH	COMPT.	HEIGHT	WIDTH	DEPTH	HEIGHT	WIDTH	
50" AISLE						BE ADVISED THAT THESE ARE PRELIMINARY LAYOUTS INTENDED TO ILLUSTRATE DESIGN INTENT AND DIMENSIONS ARE FOR REFERENCE ONLY PRIOR TO FINAL ENGINEERING						DATE: 5/18/20
												SCALE
												DWG NO 1 / 9
												DWN BY AP

170 x 95 x 72

**Example**

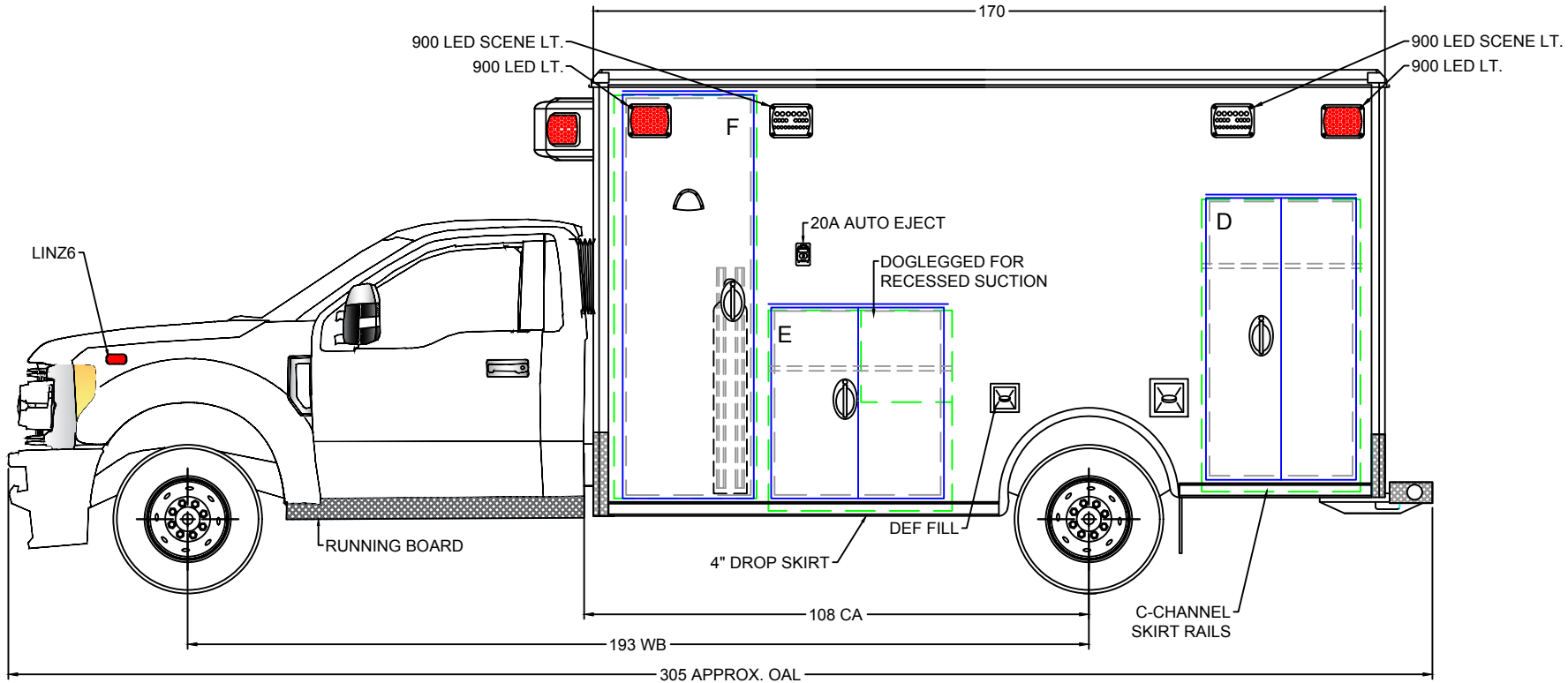

BE ADVISED THAT THESE ARE PRELIMINARY LAYOUTS INTENDED TO ILLUSTRATE DESIGN INTENT AND DIMENSIONS ARE FOR REFERENCE ONLY PRIOR TO FINAL ENGINEERING

EXTERIOR COMPARTMENT DIMENSIONS IN INCHES												TYPE 1 FORD 2020 LEFT EXT. VIEW
INTERIOR DIMENSIONS				JAMB OPENING		INTERIOR DIMENSIONS				JAMB OPENING		
COMPT.	HEIGHT	WIDTH	DEPTH	HEIGHT	WIDTH	COMPT.	HEIGHT	WIDTH	DEPTH	HEIGHT	WIDTH	
D	61.50	34.00	17.00	58.50	30.50							
E	41.75	39.25	17.00	39.00	37.00							
F	86.50	30.50	17.00	85.75	27.25							
50" AISLE											DATE 5/18/20	SCALE
											DRAWN BY AP	DWG NO 2 / 9

# Example

170 x 95 x 72

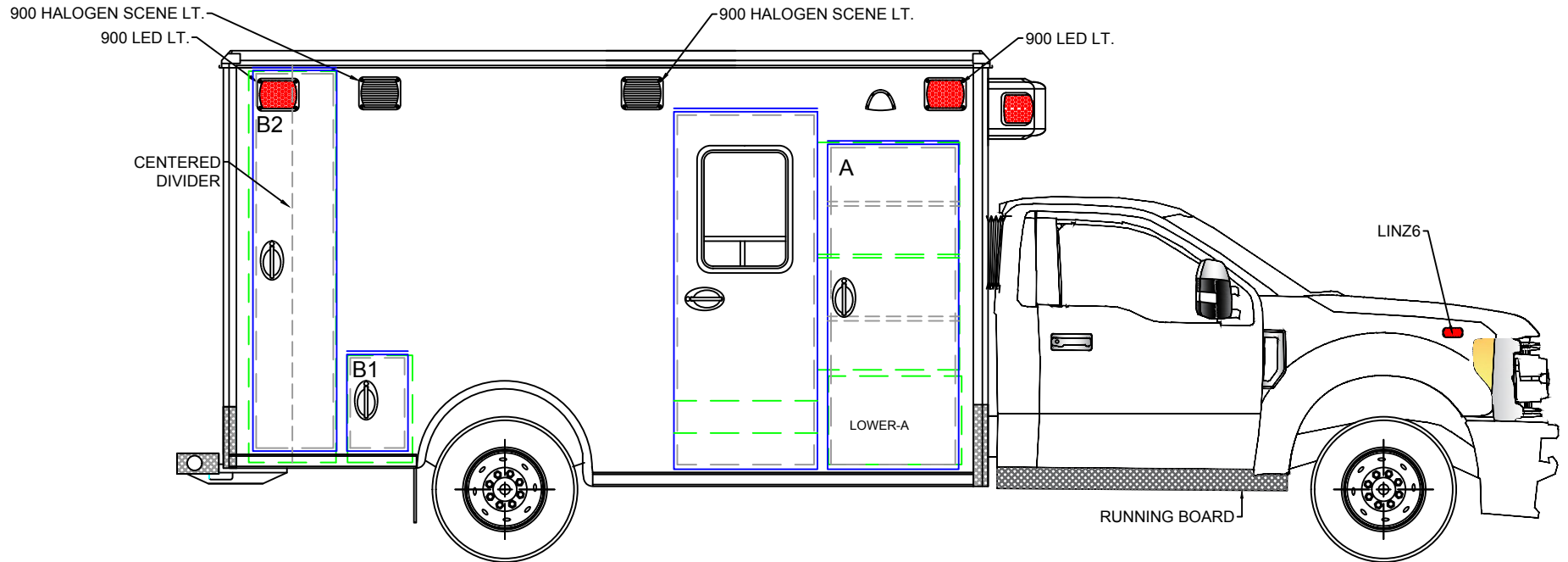

BE ADVISED THAT THESE ARE PRELIMINARY LAYOUTS INTENDED TO ILLUSTRATE DESIGN INTENT AND DIMENSIONS ARE FOR REFERENCE ONLY PRIOR TO FINAL ENGINEERING

EXTERIOR COMPARTMENT DIMENSIONS IN INCHES												TYPE 1 FORD 2020	
INTERIOR DIMENSIONS				JAMB OPENING		INTERIOR DIMENSIONS				JAMB OPENING			RIGHT EXT. VIEW
COMPT.	HEIGHT	WIDTH	DEPTH	HEIGHT	WIDTH	COMPT.	HEIGHT	WIDTH	DEPTH	HEIGHT	WIDTH	DATE	
A				69.50	27.25							5/18/20	
LOWER-A	19.50	30.50	19.00									DRAWN BY	DWG NO
B1	22.50	14.25	17.00	19.25	12.00							AP	3 / 9
B2	85.00	19.00	18.50	82.00	17.00								
50" AISLE													

# Example

170 x 95 x 72

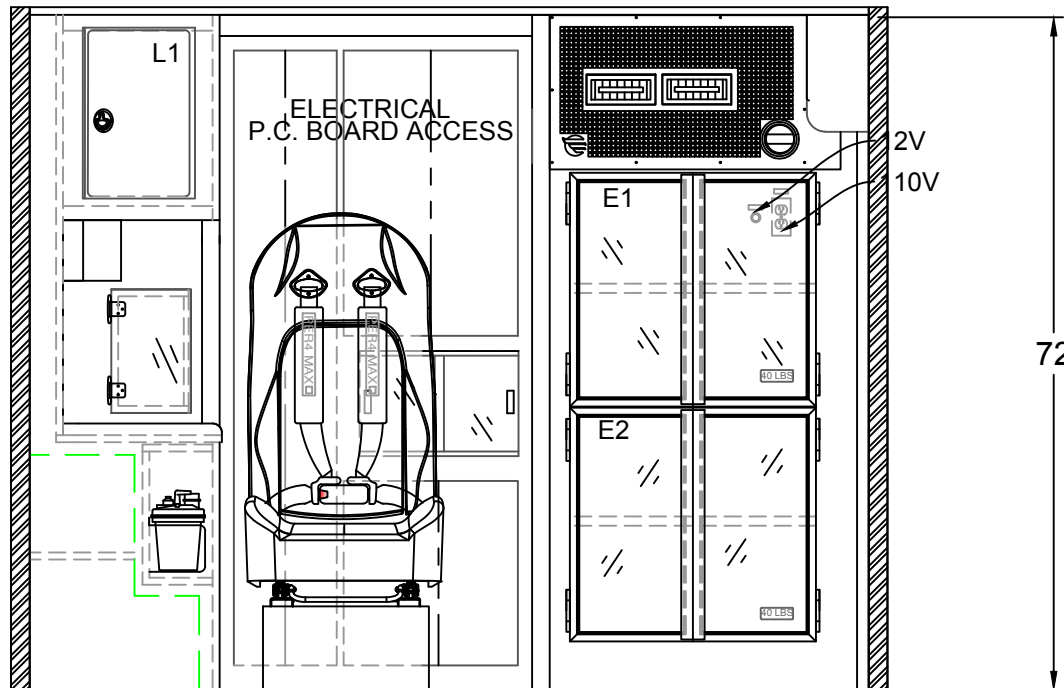

BE ADVISED THAT THESE ARE PRELIMINARY LAYOUTS INTENDED TO ILLUSTRATE DESIGN INTENT AND DIMENSIONS ARE FOR REFERENCE ONLY PRIOR TO FINAL ENGINEERING

<p><u>CABINET WEIGHT RATINGS:</u>                  NON-RESTOCKING = 40 LBS.                  RESTOCKING = 30 LBS.</p>	<p>INTERIOR CABINET DIMENSIONS IN INCHES</p>							<p>TYPE 1 FORD 2020                  BULKHEAD INTERIOR</p>		
	CABINET	HEIGHT	WIDTH	DEPTH	CABINET	HEIGHT	WIDTH			DEPTH
	E1	24.50	33.50	30.50						
	E2	24.50	33.50	30.50						
								DATE	SCALE	
								5/18/20		
								DRAWN BY	DWG NO	
								AP	4 / 9	

50" AISLE

# Example

170 x 95 x 72

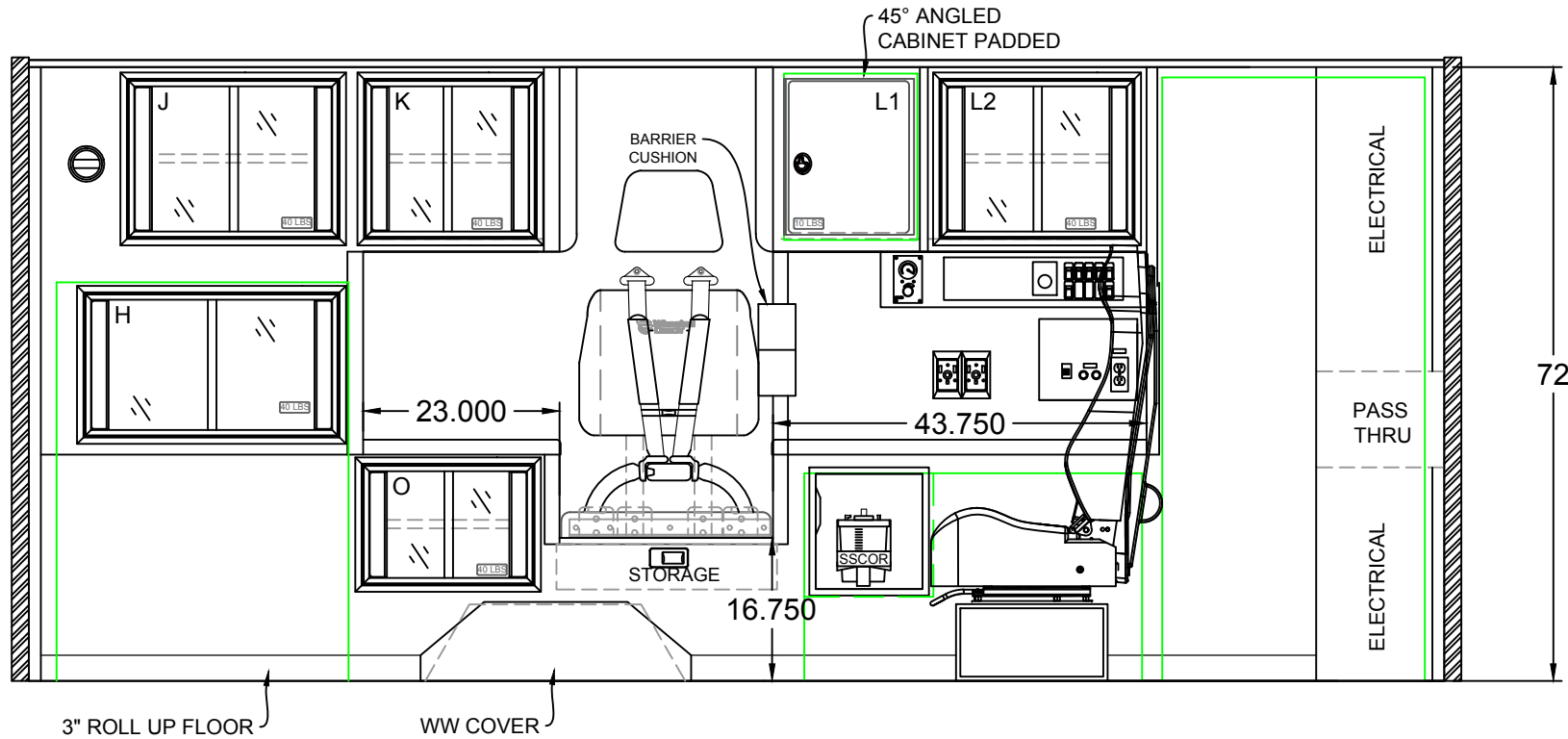

INTERIOR CABINET DIMENSIONS IN INCHES

CABINET	HEIGHT	WIDTH	DEPTH		CABINET	HEIGHT	WIDTH	DEPTH	
H	17.00	30.00	IS/OS		CPR	4.50	23.50	18.25	
J	18.75	26.25	18.25		O	14.25	20.25	18.25	
K1	18.75	20.25	18.25						
L1	19.50	18.00	16.00						
L2	18.75	24.25	16.00						

50" AISLE

CABINET WEIGHT RATINGS:  
NON-RESTOCKING = 40 LBS.  
RESTOCKING = 30 LBS.

BE ADVISED THAT THESE ARE PRELIMINARY LAYOUTS INTENDED TO ILLUSTRATE DESIGN INTENT AND DIMENSIONS ARE FOR REFERENCE ONLY PRIOR TO FINAL ENGINEERING

TYPE 1 FORD 2020

LEFT INTERIOR

DATE:	5/18/20	SCALE:	
DWN BY:	AP	DWG NO:	5 / 9

# Example

170 x 95 x 72

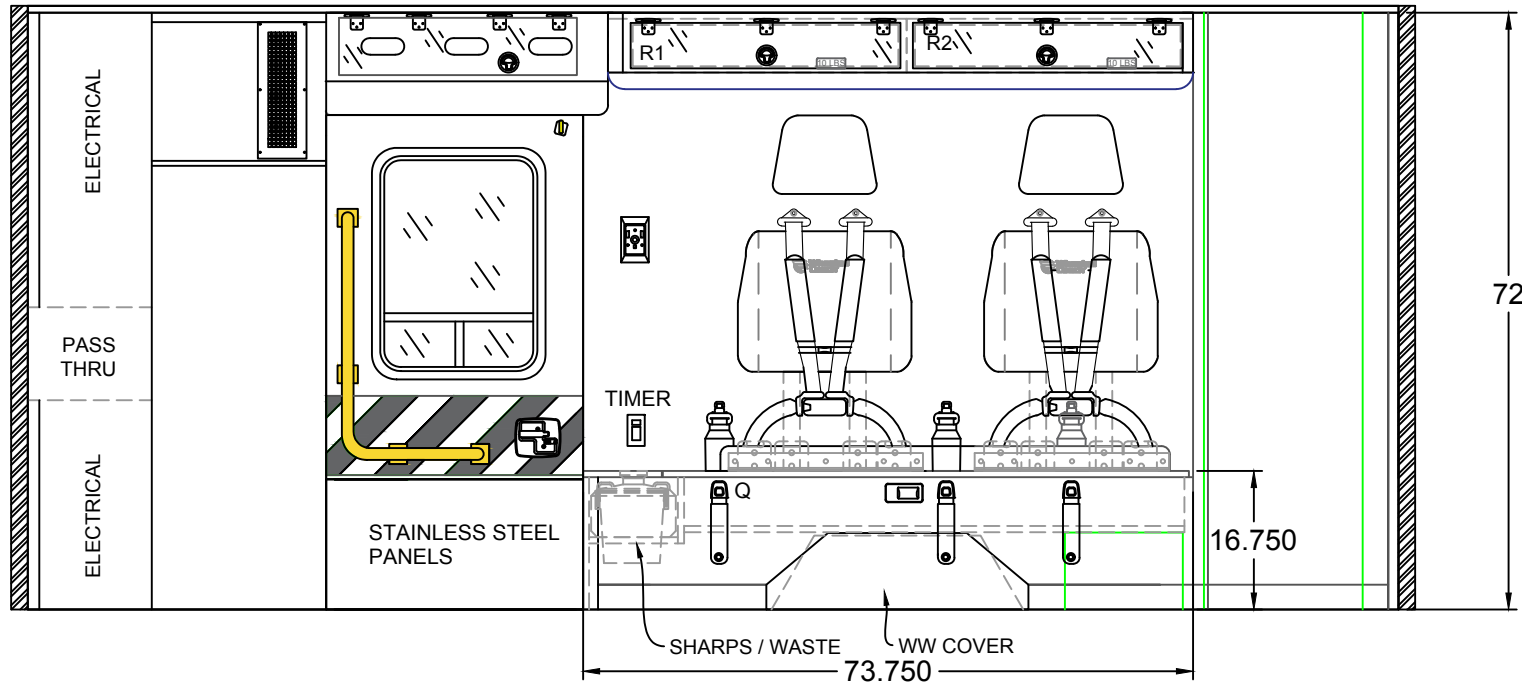

## INTERIOR CABINET DIMENSIONS IN INCHES

COMPT.	HEIGHT	WIDTH	DEPTH		COMPT.	HEIGHT	WIDTH	DEPTH	
R1/R2	5.00	32.50	7.00						
Q	5.75	60.75	16.75						

TYPE 1 FORD 2020  
RIGHT INTERIOR

DATE: 5/18/20 SCALE

DWG BY: AP DWG NO: 6 / 9

50" AISLE

CABINET WEIGHT RATINGS:  
NON-RESTOCKING = 40 LBS.  
RESTOCKING = 30 LBS.

BE ADVISED THAT THESE ARE PRELIMINARY LAYOUTS INTENDED TO ILLUSTRATE DESIGN INTENT AND DIMENSIONS ARE FOR REFERENCE ONLY PRIOR TO FINAL ENGINEERING

# Example

170 x 95 x 72

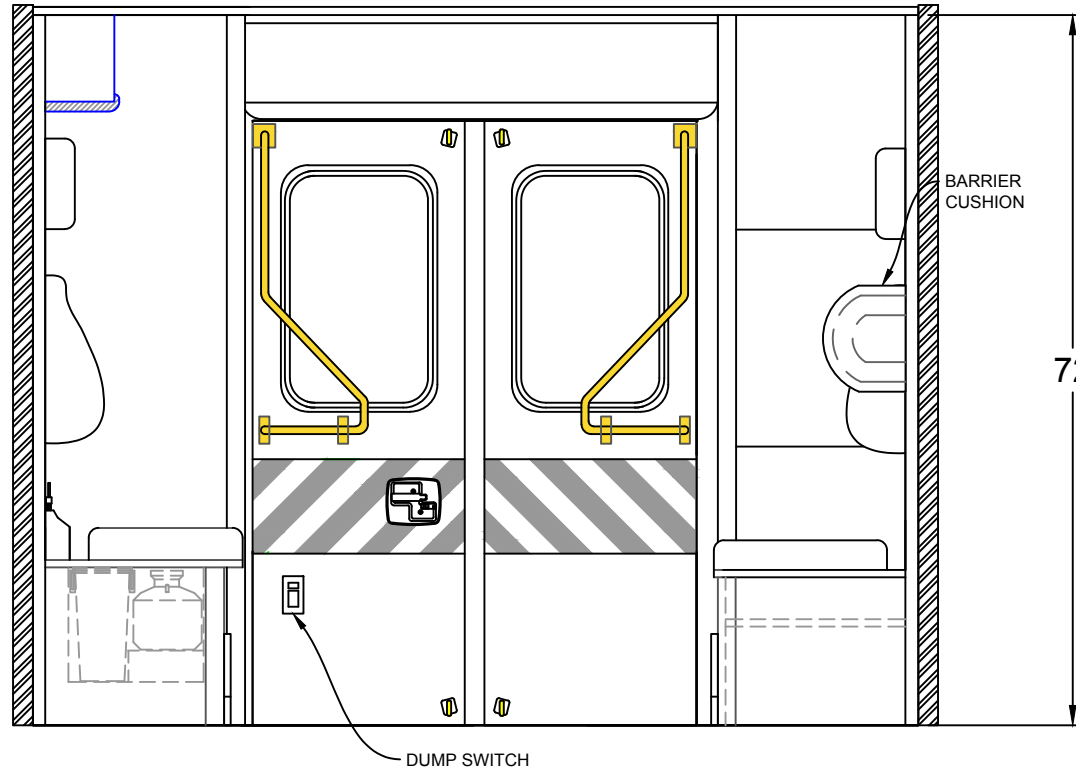

### INTERIOR CABINET DIMENSIONS IN INCHES

COMPT.	HEIGHT	WIDTH	DEPTH		COMPT.	HEIGHT	WIDTH	DEPTH	

TYPE 1 FORD 2020  
 REAR BULKHEAD INTERIOR  
 DATE: 5/18/20 SCALE  
 DWG BY: AP DWG NO: 7 / 9

50" AISLE

CABINET WEIGHT RATINGS:  
 NON-RESTOCKING = 40 LBS.  
 RESTOCKING = 30 LBS.

BE ADVISED THAT THESE ARE PRELIMINARY LAYOUTS INTENDED TO ILLUSTRATE DESIGN INTENT AND DIMENSIONS ARE FOR REFERENCE ONLY PRIOR TO FINAL ENGINEERING

# Example

170 x 95 x 72

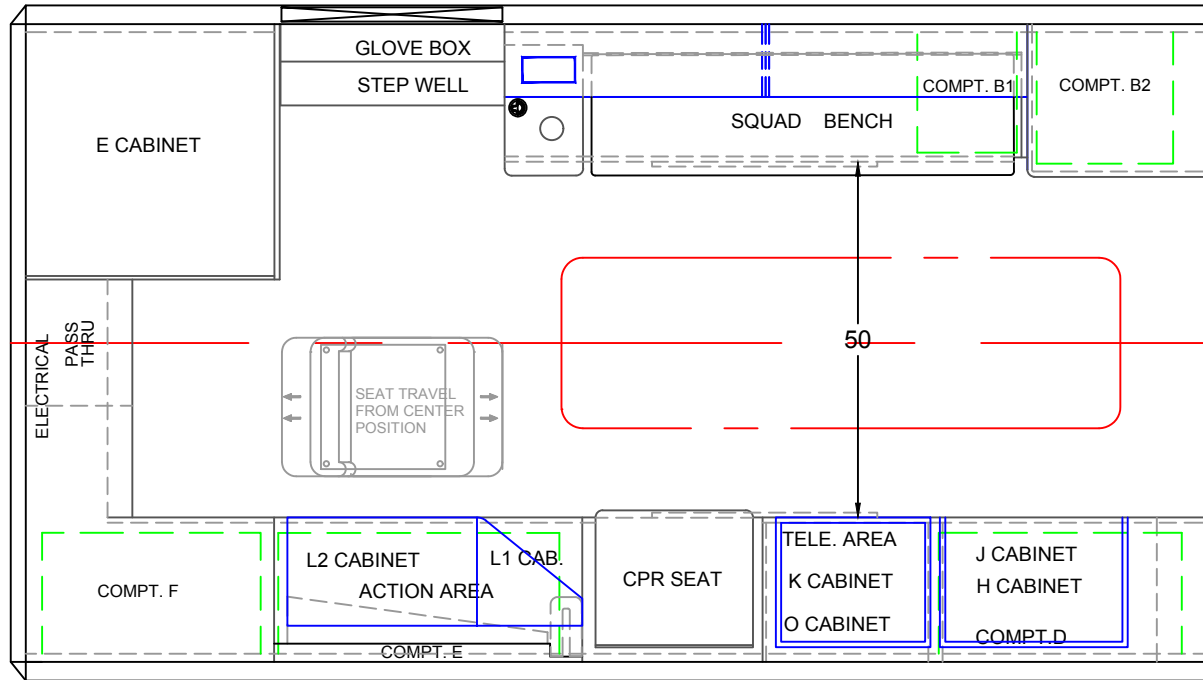

BE ADVISED THAT THESE ARE PRELIMINARY LAYOUTS INTENDED TO ILLUSTRATE DESIGN INTENT AND DIMENSIONS ARE FOR REFERENCE ONLY PRIOR TO FINAL ENGINEERING

	INTERIOR CABINET DIMENSIONS IN INCHES								
	CABINET	HEIGHT	WIDTH	DEPTH	CABINET	HEIGHT	WIDTH	DEPTH	
									TYPE 1 FORD 2020 FLOOR PLAN
									DATE: 5/18/20
									SCALE
									DWN BY AP
									DWG NO 8 / 9

50" AISLE



# Example

170 x 95 x 72

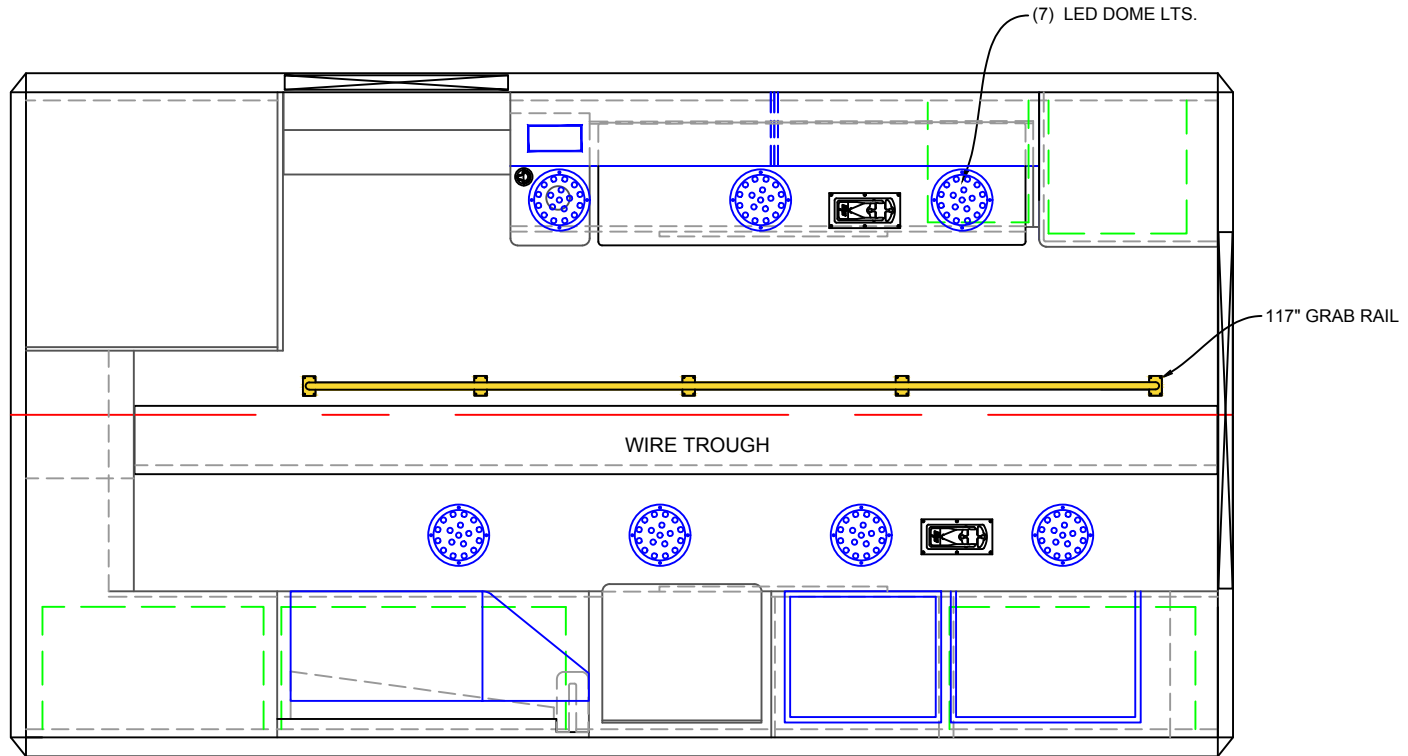

BE ADVISED THAT THESE ARE PRELIMINARY LAYOUTS INTENDED TO ILLUSTRATE DESIGN INTENT AND DIMENSIONS ARE FOR REFERENCE ONLY PRIOR TO FINAL ENGINEERING

INTERIOR CABINET DIMENSIONS IN INCHES									TYPE 1 FORD 2020 LINER	
CABINET	HEIGHT	WIDTH	DEPTH	CABINET	HEIGHT	WIDTH	DEPTH	DATE:		
									5/18/20	
									AP	DWG NO
										9 / 9

50" AISLE